

1. Communications Courses

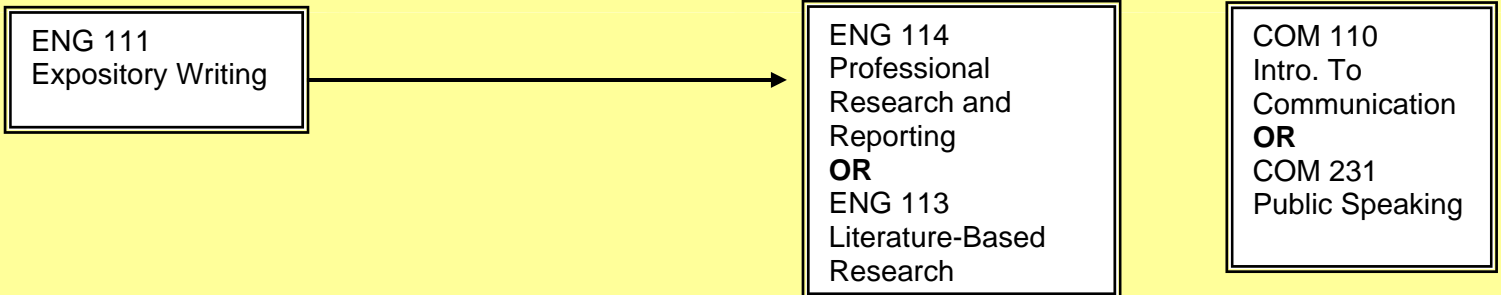

2. Mathematics Courses

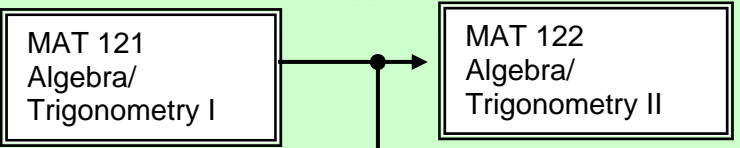

3. Physical & Natural Sciences

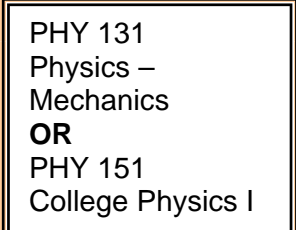

4. Social Sciences & Humanities

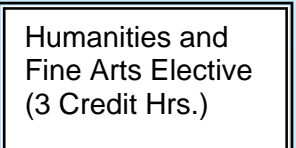
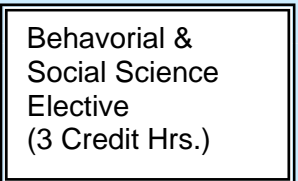

5. Technical Content

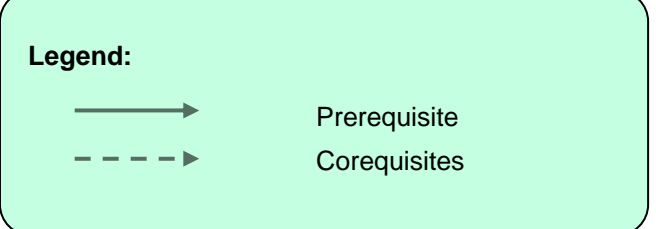
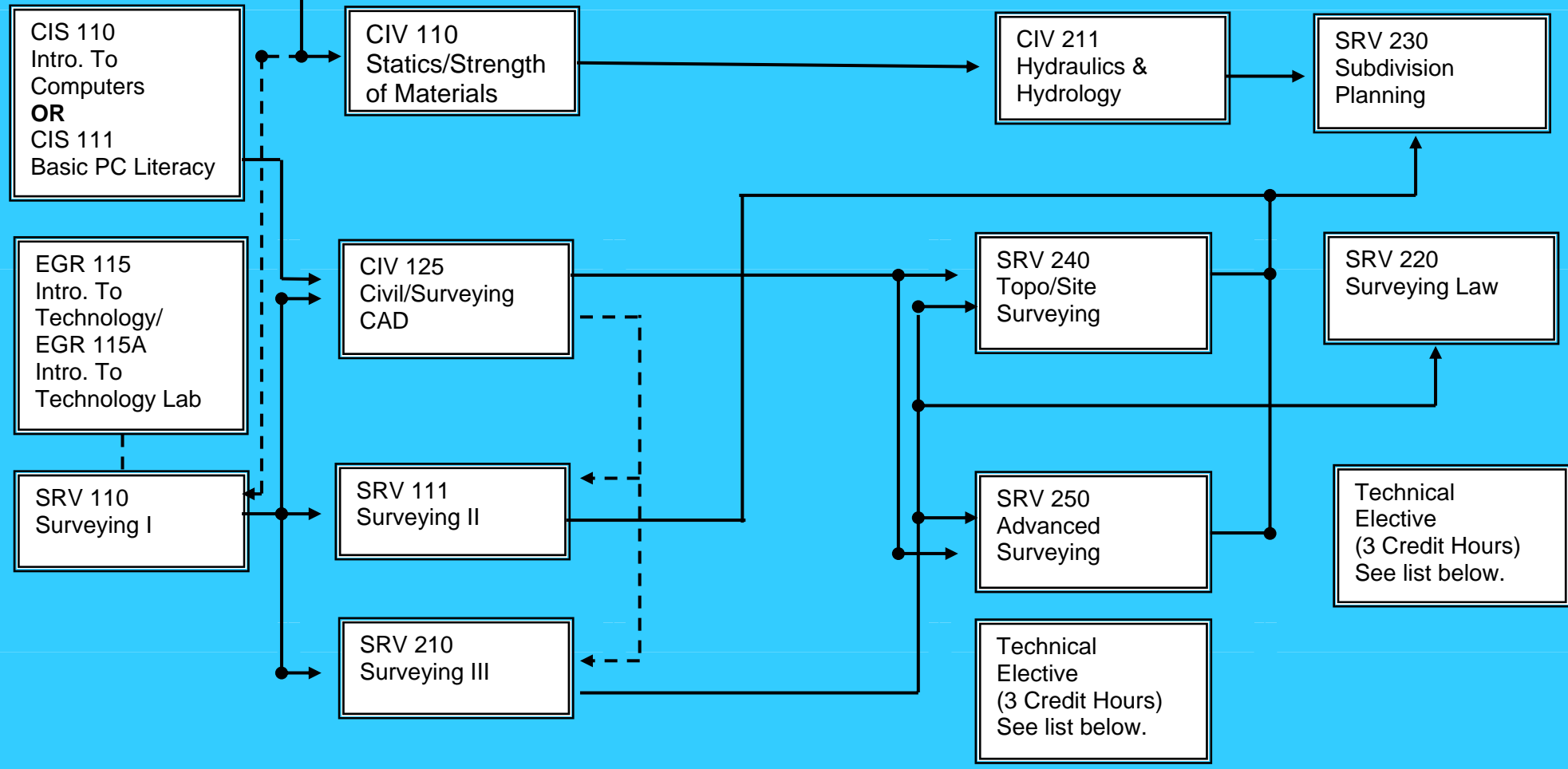

SURVEYING TECHNOLOGY CURRICULUM (A40380)

- Technical Electives**
- CIS 115 Intro. To Programming & Logic
 - CIS 152 Database Concepts & Applications
 - CIV 212 Environmental Planning
 - CIV 215 Highway Technology
 - CIV 220 Basic Structural Concepts
 - COE 112E Cooperative Work Experience I
 - MAT 223 Applied Calculus
 - PHY 132 Physics – Electricity & Magnetism
 - OR**
 - PHY 152 College Physics II
 - SRV 260 Field and Office Practice